

MR Imaging QA
Designed for
Radiotherapy

Magphan® RT

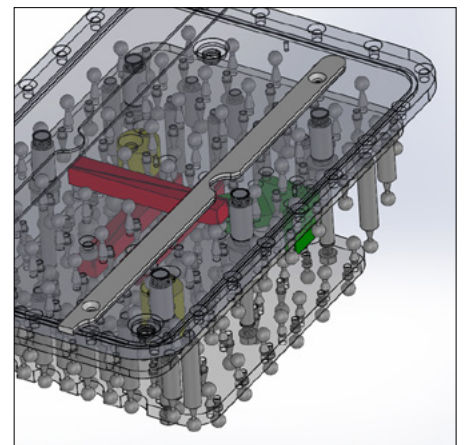

**An integrated phantom
and analysis system
with a modular,
easy-to-handle design**



MRI manufacturers have made great strides in reducing MR system distortion. Maintaining acceptable levels of distortion relies on properly controlling a long chain of conditions. A robust system of quality control measuring key imaging performance characteristics to detect significant deviations is critical for maintaining safe and effective clinical operations.

Magphan® RT 820 & 1230

Phantom Design

Magphan® RT meets the specific QA needs for MR imagers used for MR guided surgery and radiotherapy planning and guidance where measurement of large fields of view is required for the torso sizes encountered in clinical practice.

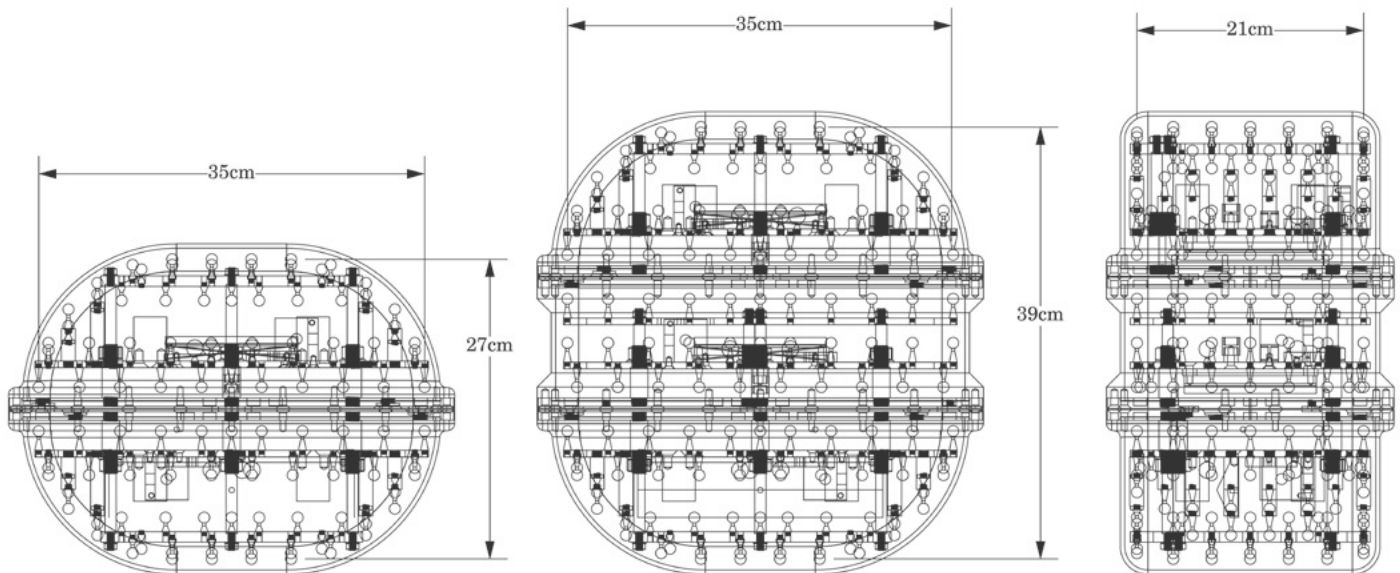

[820]
Two-piece Configuration
35 x 27 x 21 cm coverage

[1230]
Three-piece Configuration
35 x 39 x 21 cm coverage

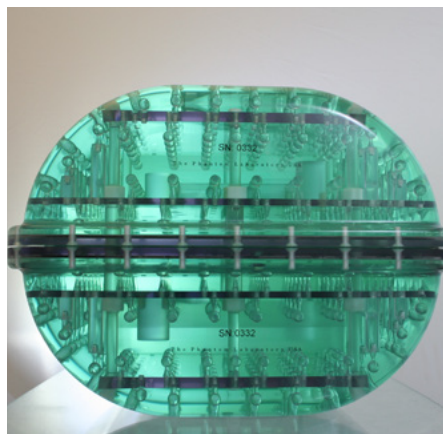

Magphan® RT 820

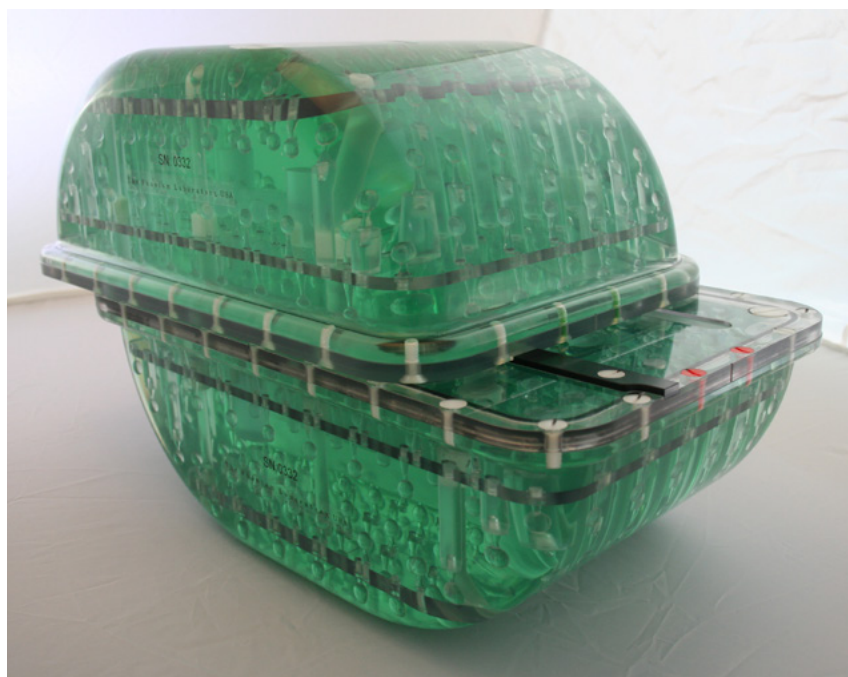

The Magphan® 820 has a two-piece configuration (top and bottom) that measures geometric distortion and uniformity over 35 x 27 x 21cm. The phantom may be upgraded to the Magphan® RT 1230 model with the purchase of a center module (TMR008) to provide an extended FOV.

The Magphan® RT 1230 can be configured for two fields of view. The full three-piece configuration measures distortion and uniformity over 35 x 39 x 21 cm. Removing the central module creates a smaller 35 x 39 x 21 cm FOV.

Magphan® RT 1230

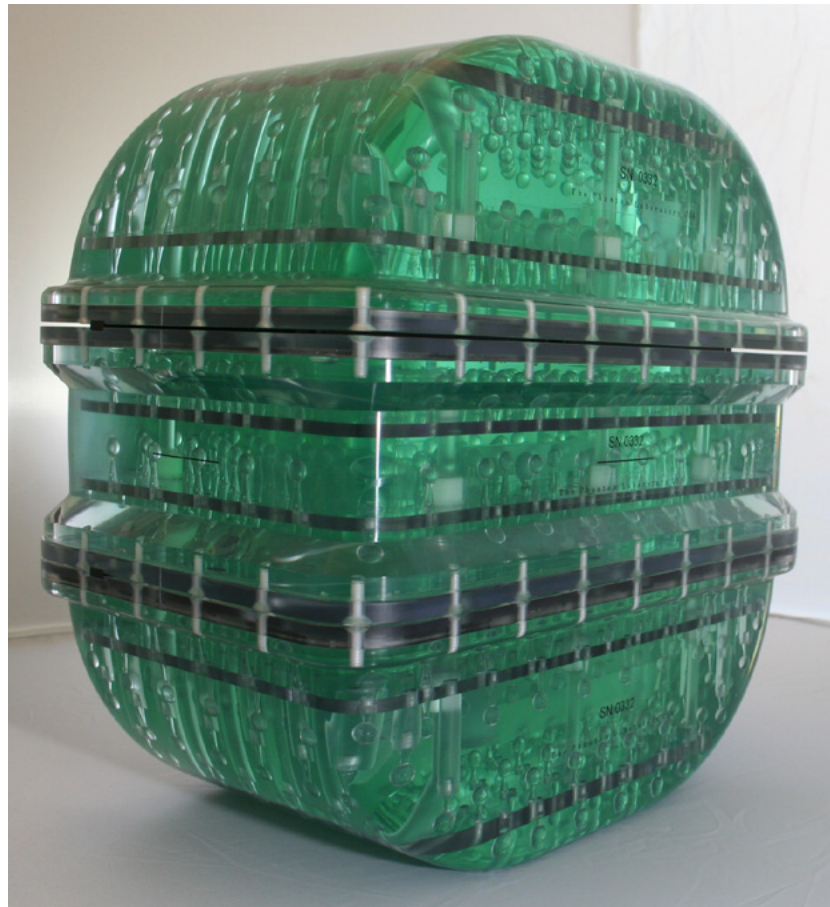

The Magphan RT's modular design keeps all individual modules under 12 kg, when filled with solution, enabling the phantom to be handled by a single person without special equipment. This design not only allows for easy handling of the phantom but also provides for future system expansion with additional measurement modules.

The Phantom Laboratory + **imageOwl**

Magphan® RT: MR Imaging QA Designed for Radiotherapy

Phantom Analysis

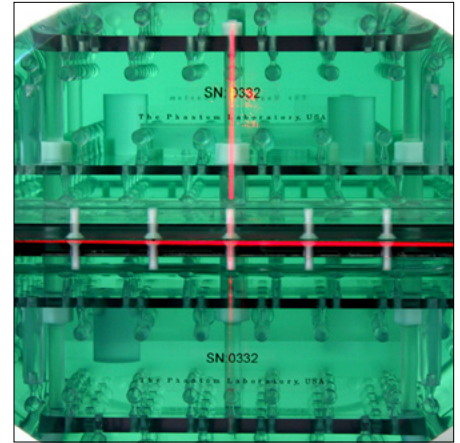
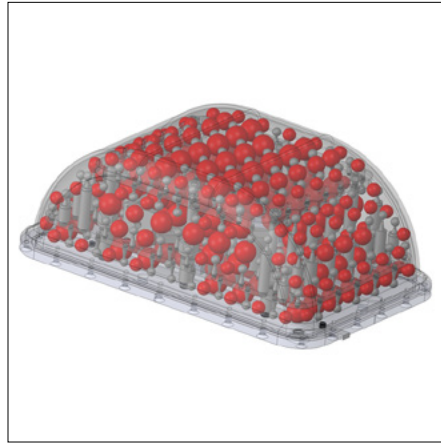
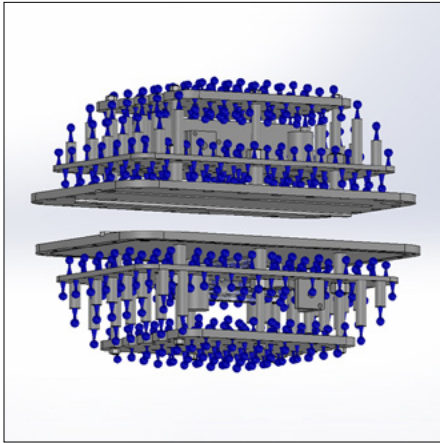

Geometric Distortion

The locations of several hundred 1cm sphere fiducials are measured across the volume of the phantom. These measured locations are compared to known locations to generate a 3D distortion map. The phantom modules are designed to fit together precisely and the analysis accounts for any residual positional offsets between components. Beyond producing a distortion map, the system tracks several key indicators such as maximum and mean high 10% distortion along the cardinal axes. Analysis of optimized gradient rescaling factors for different objectives is included.

Uniformity

Uniformity can be a useful indicator for common failure mechanisms in subsystems like the RF coil element. The uniformity is measured at several hundred uniform spherical sub-volumes throughout the phantom. The mean signal, normalized standard deviation, and spread are calculated.

Laser Alignment

The phantom contains markers for alignment with positioning lasers. The analysis provides data on translation and rotation of the phantom in all three cardinal axes.

Phantom Analysis, continued

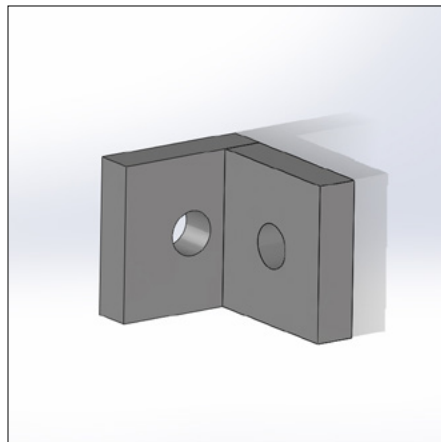
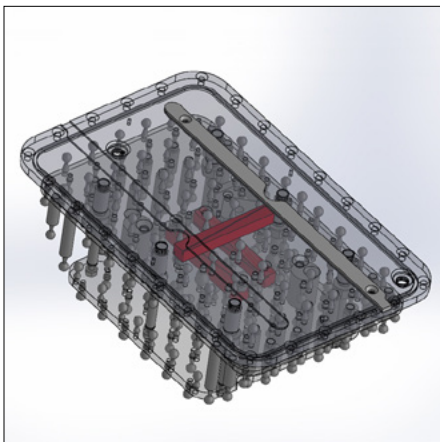
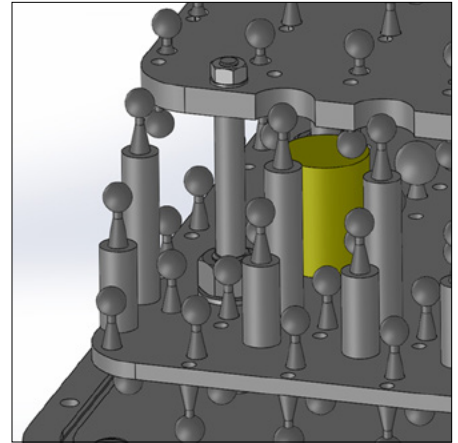
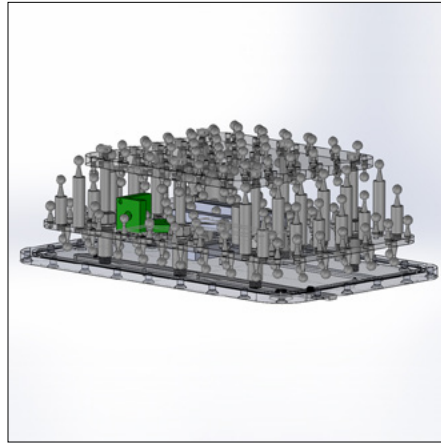
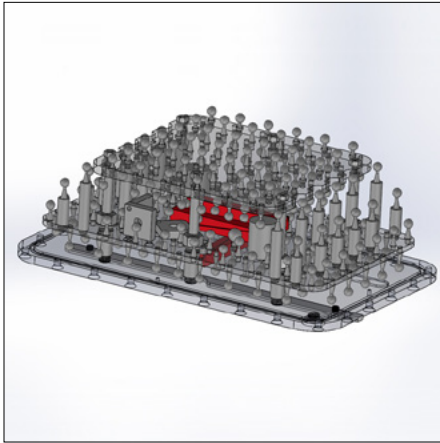

Signal-to-Noise Ratio

The signal-to-noise ratio is measured at several places throughout the phantom. Longitudinal tracking of SNR can give early warning of component degradation or failure.

Slice Thickness

We provide slice thickness ramps to provide an objective slice thickness measurement on all three orthogonal axes. The automated routine provides higher quality slice thickness measurements versus manual measurements on clinical sequences.

Resolution

The Magphan RT system measures the point spread and modulation transfer functions from circular features in the phantom all three image planes.

Magphan® RT Throughput

Along with taking a comprehensive physics approach to designing the test objects our engineers focused on user interaction and efficiency. The most obvious feature is the fact that the phantom is made up of 12kg sections. This enables easy setup by a single person.



Each section of the Magphan® RT phantom is enclosed in a wood case. The case hardware is made from stainless steel to reduce magnetic susceptibility.

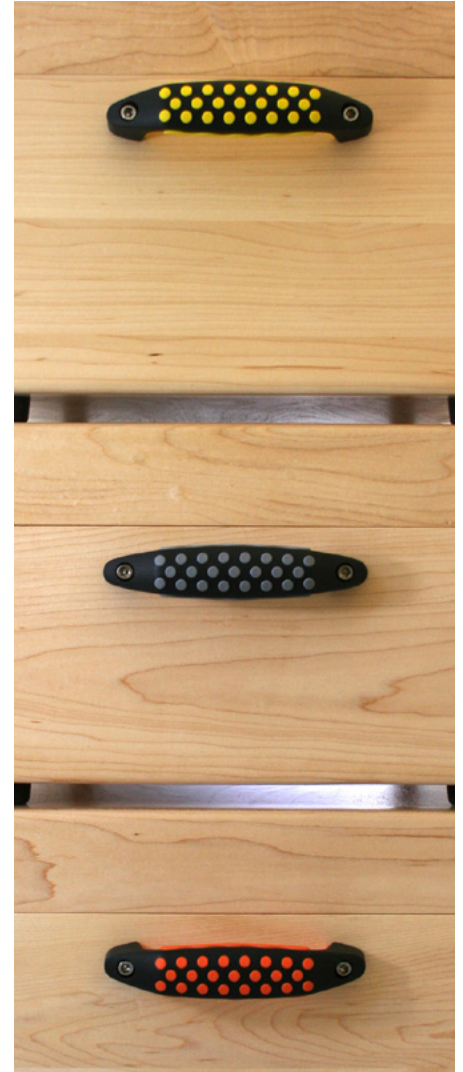

Each case comes with color coded handles so the bottom, top and middle sections can be easily identified without opening the case.

Magphan® RT Throughput, continued

Case has front opening panel allowing the phantom to be easily lifted for positioning on the patient couch.

Colored screws

Each phantom has colored screws at one end to simplify position identification for assembly. When assembled the colored screws are positioned over each other. In the 820 configuration, green screws are above orange and in the 1230 configuration, green over green and orange over orange.

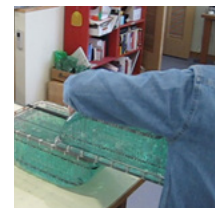
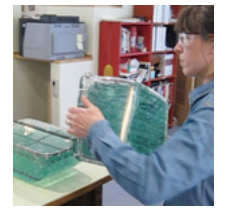
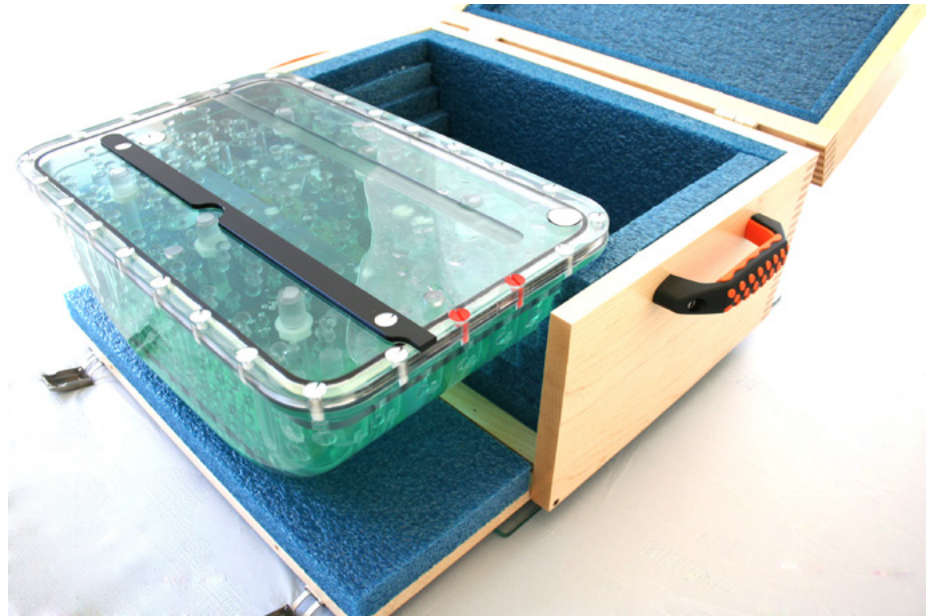

The sections of the phantom are assembled on the patient couch for scanning. There are slides that enable each section to be easily slide over the other preventing the need to lean over the table when assembling the phantom.

Analysis Service

The analysis service is hosted by the Image Owl Total QA® for Magphan RT service and is included in the purchase price for 2 years. The service provides the following benefits:

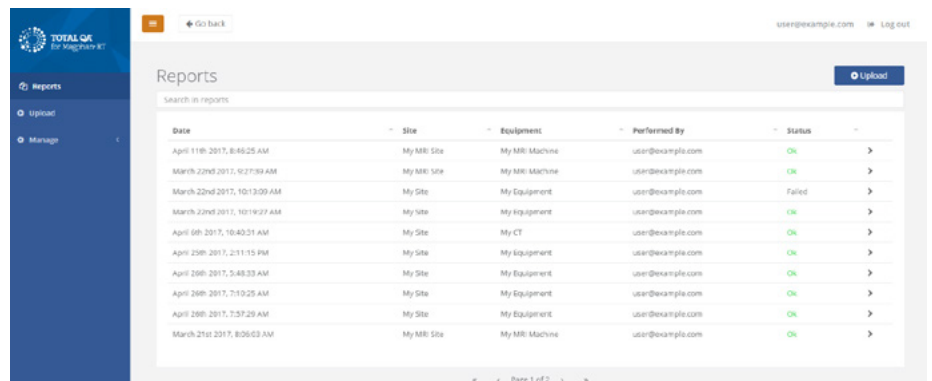
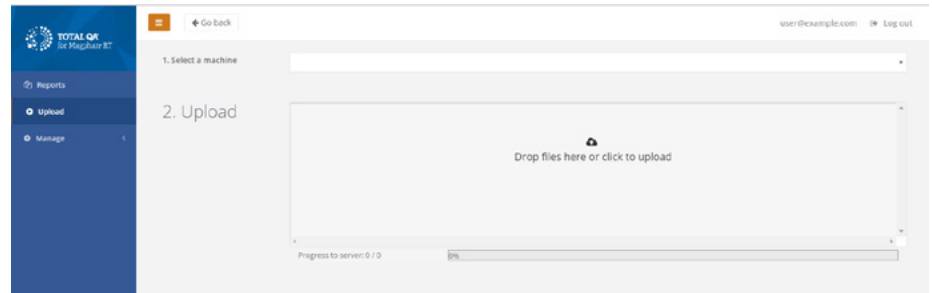

Complete Automation

Simply upload the complete DICOM scan series of the phantom. The service automatically identifies the features, performs the analysis and prepares a comprehensive report. Analysis results are saved in a cloud-based database for longitudinal studies, process control, and inter-machine comparisons.

No Installation or Manual Updates Required

The service is accessible from any web-enabled device and requires no local installation. Updates to the service are automatic and require no user actions.

API Available

The Total QA® for Magphan RT service includes an API that allows users to extend the system with custom analyses or interfaces.

Analysis Service, continued

Reporting, Trending and Data Analysis included

The Total QA system provides an informative report, tracks all parameters over time and provides comparative analysis tools between machines.

Upgradeable to a full Total QA service

The Magphan RT analysis can be seamlessly integrated into a full Total QA[®] service for managing all RT QA data for a facility.

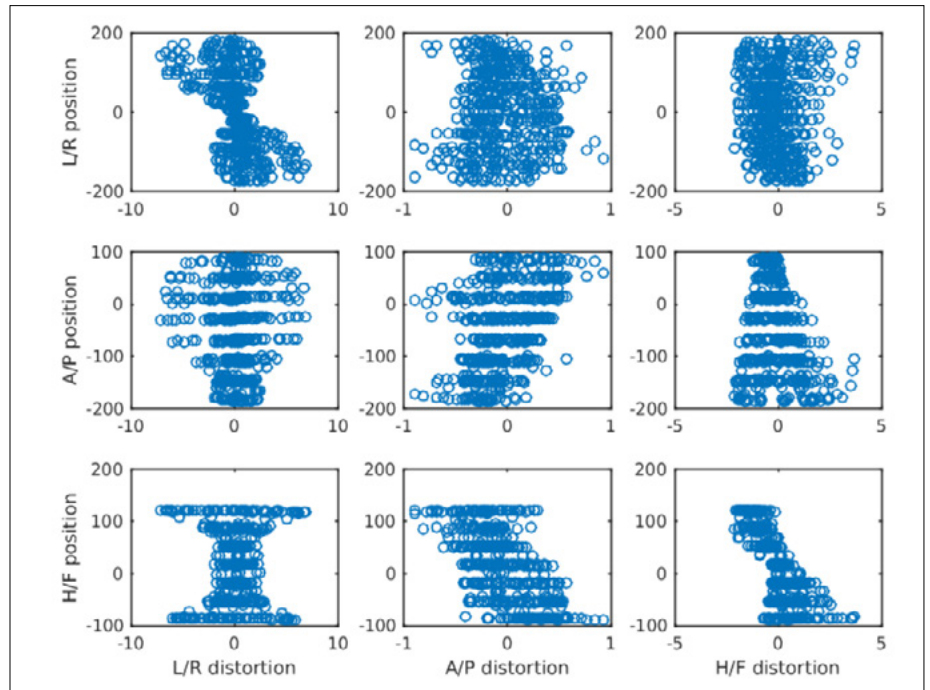
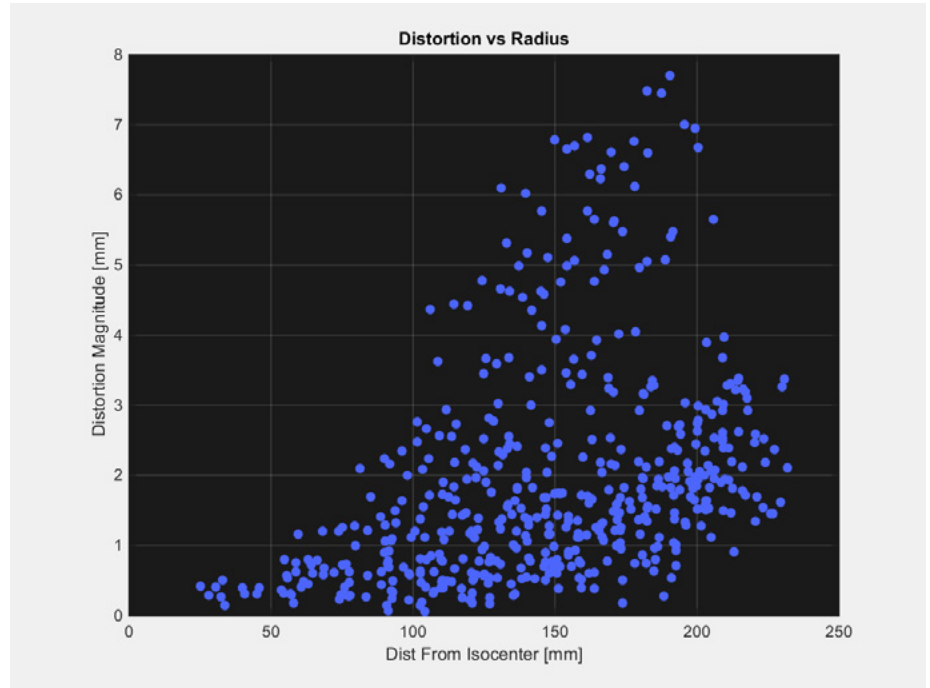

**For more information on Magphan® RT,
contact**

The Phantom Laboratory:

email: info@phantomlab.com

phone: +1 518-692-1190

www.phantomlab.com/magphan-rt

Image Owl, Inc.:

email: info@imageowl.com

phone: + 1 518-692-0226

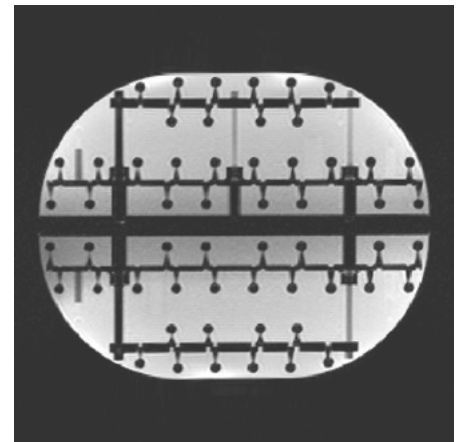
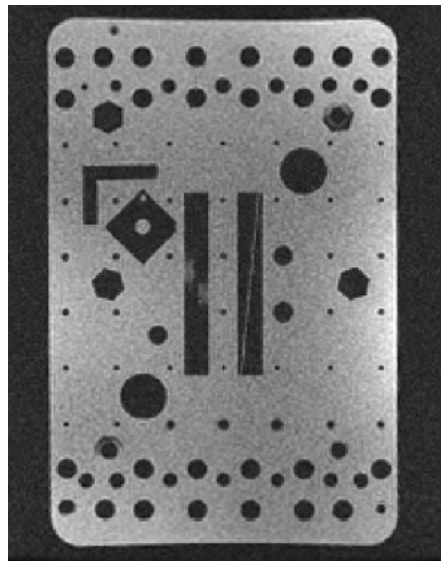

The Phantom Laboratory + **imageOwl**

Magphan® RT: MR Imaging QA Designed for Radiotherapy